

Minuteman[®]
Excellence Meets Clean



EZ Mop 360° User Manual

Table of Contents

1. GENERAL INFORMATION	3
1.1 IMPORTANT INFORMATION	3
1.2 AIM OF THE MANUAL	3
1.3 TERMINOLOGY AND SYMBOLS	3
1.4 SYMBOLS AND WARNINGS	4
1.5 INTENDED USE AND UNINTENDED USE	4
1.6 TECHNICAL MODIFICATIONS	4
1.7 PRODUCT IDENTIFICATION	5
1.8 TECHNICAL SUPPORT	5
2. SAFETY INFORMATION	6
2.1 BASIC RECOMMENDATIONS	6
3. HANDLING INFORMATION	8
3.1 DIMENSIONS AND WEIGHT OF PACKAGE	8
3.2 LIFTING AND TRANSPORTATION OF THE MACHINE	8
3.3 INSPECTION UPON DELIVERY	10
3.4 UNPACKING	10
3.5 ASSEMBLING THE MACHINE	11
4. TECHNICAL INFORMATION	11
4.1 GENERAL DESCRIPTION OF COMPONENTS	11
4.2 INSPECTION UPON DELIVERY	11
4.3 BLOCKING / UNLOCKING SQUEEGEE LIFTING	12
4.4 CONTROL PANEL	12
4.5 SUCTION POWER ADJUSTMENT CONTROL	12
4.6 DIMENSION AND TECHNICAL DATA	13
5. USING THE MACHINE	13
5.1 PREPARING THE MACHINE	13
5.2 RECHARGING THE BATTERY	14
5.3 FITTING AND REMOVING THE BRUSH	15
5.4 BRUSH TYPES	16
5.5 MOVING THE MACHINE	16
5.6 FITTING AND REMOVING THE SQUEEGEE	17
5.7 REPLACING THE SQUEEGEE BLADES	17
5.8 FILLING AND EMPTYING THE TANK	18
5.9 DRAINING THE RECOVERY TANK	19
5.10 OPERATING THE MACHINE	20
5.11 FLOOR CLEANING INSTRUCTIONS	20
6. MAINTENANCE	22
6.1 TANKS	22
6.2 DETERGENT SOLUTION TANK FILTER	22
6.3 SUCTION HOSE	22
6.4 SQUEEGEE	23
6.5 VACUUM FILTER	23
6.6 ACCESSORIES	24
6.7 MACHINE BODY	24
6.8 MAINTENANCE SCHEDULE	24
6.9 EXTRAORDINARY MAINTENANCE	25
6.10 RECOMMENDED SPARE PARTS	25
7. TROUBLESHOOTING	26
Warranty	28

1. GENERAL INFORMATION

1.1 IMPORTANT INFORMATION

- The improper use of the machine or its use by unauthorised or unskilled personnel to carry out certain tasks and/or during training courses.
- The machine being used in a manner that does not conform to national safety and accident prevention regulations.
- The disabling or removal of safety devices installed on the machine.
- The improper installation and / or connection to the intended power supplies (power supply defects).
- The lack of or inadequate preventive maintenance.
- Making modifications to or carrying out unauthorised work on the machine.
- The use of non-original or unsuitable spare parts.
- The total or partial failure to comply with the instructions provided.
- Exceptional conditions.

1.2 AIM OF THE MANUAL

To make it easier to look up and read about the subjects of interest, refer to the table of contents at the beginning of the manual.

This manual has been written by the manufacturer and is an integral part of the product. As such, it should be kept safely for the entire service life of the machine until it is demolished.

The customer must make sure that operators have read or are familiar with the contents of this manual and that they strictly follow the instructions provided.



The only way to obtain the best results in terms of safety, performance, efficiency and durability of your product is to always comply with the instructions provided in this manual.

Failure to comply with these instructions may cause injury to persons or damage to the machine, the surface that is being cleaned and to the environment. Under no circumstances can such injuries or damage be attributed to the manufacturer.

1.3 TERMINOLOGY AND SYMBOLS

TERM	DEFINITION
MACHINE	This replaces the commercial name of the machine to which this manual refers.
OPERATOR	A person who normally uses the machine and who is familiar with how to operate it, as well as being familiar with the use of various types of detergent but who is not able to carry out work on the machine that requires specific technical skills.
TECHNICIAN	A person who has the necessary requisites (experience, technical skills and legislative and regulatory knowledge) that allows him to carry out any type of work required and that has the ability to recognise and avoid possible hazards during the installation, operation, handling and maintenance of the machine.

1.4 SYMBOLS AND WARNINGS

	<p>DANGER! Symbol that draws attention to essential information to avoid serious (or extreme) consequences that affect the health of persons, the integrity of the product and damage to the environment in which it is used.</p>
	<p>CAUTION Symbol that accompanies information containing procedures and/or instructions that are essential to understand and follow to avoid damage to the machine and to the environment in which it is used.</p>
	<p>NOTE: <i>Symbol used to highlight important information which if ignored, could cause damage to the machine.</i></p>

1.5 INTENDED USE AND UNINTENDED USE

The machine referred to in this manual (EZ Mop 360°) is an operator-controlled hard floor scrubber-dryer. It must be used to scrub and vacuum liquids on flat, hard, horizontal, smooth or moderately rough and uniform floors that are free from obstacles in both civil and industrial environments.

	<p>DANGER! Any other use is strictly prohibited! Please read the safety information provided in this manual very carefully.</p>
---	--

The scrubber-dryer distributes a quantity of a solution consisting of water and detergent (that can be regulated) onto the surface to be cleaned, while the brushes remove any dirt from the surface. The machine's vacuum system, with the aid of the squeegee, completely dries the liquids and removes the dirt removed by the front brushes in a single pass. By matching the correct detergent with various types of brush (or abrasive disks), the machine can adapt to all the various floor-dirt combinations.

1.6 TECHNICAL MODIFICATIONS

This machine was designed and built in accordance with the fundamental requirements for user health and safety pursuant to the European directives. The CE mark was therefore placed on the rating label. The European directives to which the appliance is compliant are referred to in the Certificate of Conformity, attached to this manual. This certificate will cease to be valid if the appliance is modified in any way without the manufacturer's prior authorisation. The manufacturer reserves the right to make technical modifications to the product without prior notice in order to make technical upgrades or improvements. For this reason, some details of your machine may be different from the information contained in the sales catalogues or the illustrations shown in this booklet. Nevertheless, this will not affect safety or invalidate the information provided regarding it.

1.7 PRODUCT IDENTIFICATION

Make sure that there is a rating label containing the serial number and the CE mark attached to the machine. If there isn't, please inform your dealer immediately.



Minuteman International 800-323-9420 www.minutemanintl.com		CE	
Model	MM14OP	Release	04
Serial N.	D40MVO1605	Year	2018
Weight	28 kg	Power	540
Tension	36 volt dc		

The rating plate contains the following information:

- Manufacturer's identification data
- CE mark
- model
- serial number
- total power rating
- year of construction

1.8 TECHNICAL SUPPORT

	<p>DANGER! All maintenance work or the replacement of accessories must be carried out in areas with adequate lighting and only after having disconnected the machine from the power supply by unplugging the battery connector.</p>
	<p>NOTE: <i>All work on the electrical system and all maintenance and repair work (especially work not specifically described in this manual) should only be carried out by skilled personnel with experience in the field and knowledge of the relevant safety regulations. Only ORIGINAL SPARE PARTS, supplied exclusively by the manufacturer, should be used. Only these parts can provide the assurance that the appliance will work safely and efficiently. Do not use parts that have been removed from other machines or other kits as replacement parts. Do not wait until the components are worn out; replacing a component at the right time means that the machine will perform better and at the same time savings will be made by avoiding further damage.</i></p>

The manufacturer provides its customers with a Technical Support Service to help resolve any issues there may be regarding the use and maintenance of the machine.









Any requests for assistance must be made after having carefully assessed the problems and their causes.

When making a written request, please specify the following:

- Machine model
- Serial number
- Details of the problem
- The checks carried out
- Any adjustments made and their effect
- Any other information you think may be useful

2. SAFETY INFORMATION

2.1 BASIC RECOMMENDATIONS

	<p>NOTE: Read the “instructions manual” before starting up, using, or carrying out scheduled or unscheduled maintenance or any other work on the machine.</p>
	<p>CAUTION Strictly comply with all the instructions provided in this manual and those regarding the batteries and battery chargers (pay particular attention to safety warnings and danger notices). The manufacturer declines all liability for injury or damage due to the failure to comply with the above-mentioned instructions.</p>
	<p>NOTE: Before using the machine, make sure that all parts are in their correct position.</p>
	<p>CAUTION The machine must only be used by personnel who have been trained to use it, who have proven their ability to use it and who have been expressly instructed to use it. To avoid unauthorised use, when not in use, store the machine in a place that is not accessible by unauthorised personnel. Never allow minors to use the machine. Never use this machine for any purpose other than for those for which it was specifically designed. Consider the type of building in which it is to be used and comply fully with the current rules and safety regulations of the building.</p>
	<p>DANGER! Never use the machine in poorly lit areas, in explosive environments, in the presence of dirt that is hazardous to health (dust, gas etc.), on roads or public passageways and outdoors in general.</p>
	<p>CAUTION The machine operating temperature range is +4°C to + 35°C. When not in use, store the machine in a dry and non-corrosive environment in which the temperature is between + 10°C and + 50°C. The humidity range for the machine is between 30% and 95%, whatever the conditions.</p>
	<p>DANGER! Never use or vacuum liquids, gases, dry dust, acids and solvents (e.g. paint thinners, acetone etc.), even if diluted that are inflammable or explosive (e.g. petrol, fuel oil etc.). Never vacuum objects that are on fire or incandescent.</p>
	<p>CAUTION Do not use the machine on slopes or ramps that are steeper than 2%. On slight slopes, never use the machine sideways, always manoeuvre it with care and never reverse. When transporting the machine on steep ramps or slopes, be very careful to prevent it tipping over and/or accelerating uncontrollably. Use only the lowest speed! The machine should only negotiate ramps and/or steps with the brush head and squeegee raised. NEVER leave the machine on a slope.</p>

	<p>NOTE: <i>Never leave the machine unattended without first making sure that it cannot move accidentally and that it is disconnected from the power supply.</i></p>
	<p>DANGER! When using the machine, pay attention to other people, especially children in the area where the machine is being used.</p>
	<p>CAUTION Do not use the machine to transport persons / things or to tow things. Do not tow the machine.</p>
	<p>NOTE: <i>Do not for any reason use the machine as a support for any amount of weight. Do not obstruct the ventilation and heat discharge vents.</i></p>
	<p>CAUTION Do not remove, modify or bypass the safety devices. Operators should always use personal protective equipment (both when using the machine and when carrying out maintenance on it):</p> <ul style="list-style-type: none"> • apron or overalls • non-slip waterproof footwear • rubber gloves • goggles and ear protectors • breathing mask <p>Before starting to use the machine, remove jewellery, watches, ties and other items that could potentially cause serious injury. Never insert hands between moving parts.</p>
	<p>NOTE: <i>Do not use detergents other than the ones intended and follow the instructions on the relative safety data sheets. Detergents should be kept in a place that is inaccessible to children. In case of contact with the eyes, rinse immediately with copious amounts of water. If swallowed, consult a doctor immediately.</i> <i>Make sure that the power outlets used for the battery charger are connected to an efficient earthing system and that they are protected by magneto thermal and differential circuit breakers.</i></p>
	<p>DANGER! Do not place tools on top of the batteries: they may cause a short-circuit or an explosion. In the presence of particularly strong magnetic fields, assess the possible effect they may have on electronic control devices. Never clean the machine using water jets.</p>

	<p>NOTE: The fluids that are recovered contain detergents, disinfectant and water together with organic and inorganic substances collected whilst the machine is in use. They must be disposed of according to the current applicable legislation.</p>
	<p>NOTE: Before each use, check the machine. In particular, check that the battery charging cable and connector are in good condition and safe for use. If they are not in perfect condition, do not use the machine for any reason until repairs have been carried out by an authorised technician.</p>
	<p>NOTE: Turn off the vacuum motor immediately if you notice any foam or liquid leaking from the appliance. Do not use the machine on textile floor coverings such as rugs, carpets etc. The use of wax, foaming detergents or dispersions may cause serious damage to the machine or clog the hoses.</p>
	<p>CAUTION If the machine breaks down and/or malfunctions, turn it off immediately (unplug it from the electric power supply or the batteries) and do not tamper with it. Contact one of the manufacturer's technical support centers.</p>

3. HANDLING INFORMATION

3.1 DIMENSIONS AND WEIGHT OF PACKAGE

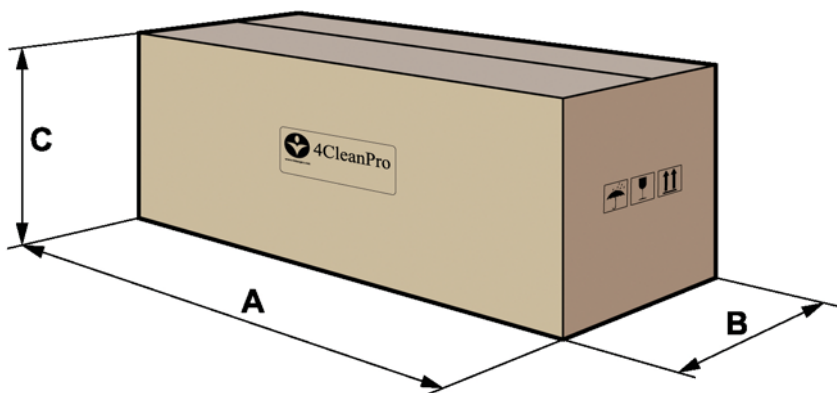

Weight:	38 kg
Volume:	0,22 m3
A	1250 mm
B	510 mm
C	520 mm

3.2 LIFTING AND TRANSPORTATION OF THE MACHINE

	<p>CAUTION When lifting or transporting the machine, make sure that the packaged machine is securely anchored to prevent it from tipping over or falling accidentally.</p>
--	---

Vehicle loading and unloading operations must be carried out with adequate lighting. The packaged machine must be handled using suitable equipment. Care must be taken not to damage/hit any part of the packaging, not to tip it over and to be careful when placing it on the ground.

Symbols used on the packaging



Fragile, handle with care.

Indicates that the contents of the package are fragile and must be handled with the utmost care.



Keep dry

Indicates that the package should be kept in a dry place.



This way up.

Indicates that the package must be stored the right way up.

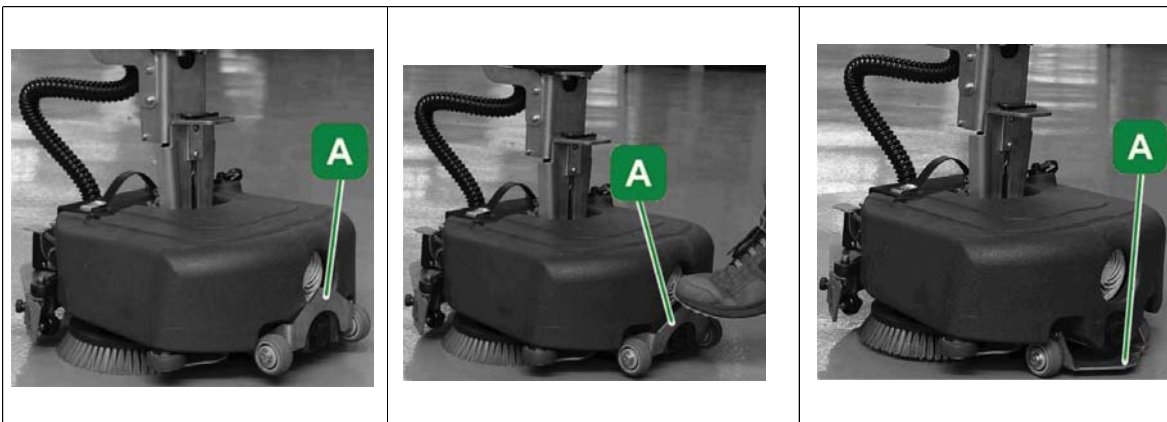

With the machine in POWER OFF, pressing and rotating the front lever A, the machine will rest on the three wheels and lifts the brushes OFF the floor. In this position it is possible to move the machine by maneuvering it as in the working phase without blocking the handle.



3.3 INSPECTION UPON DELIVERY

When the goods are delivered (machine, battery or battery charger) by the carrier, carefully check the condition of the packaging and its contents. If the contents have been damaged, inform the carrier immediately.

The package contains the following:

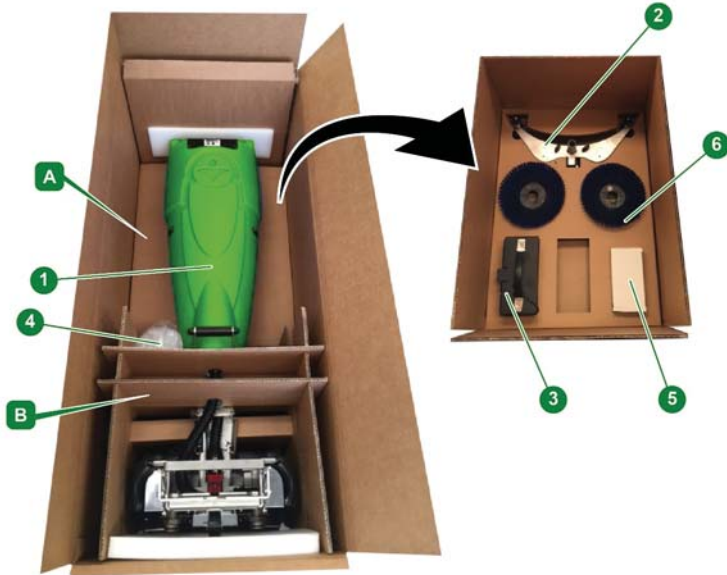

1. Scrubber-dryer
2. Squeegee
3. Battery
4. Graduated container
5. Battery charger
6. Brushes

3.4 UNPACKING

To unpack the machine, proceed as follows:

1. Remove the graduated container 4
2. Remove the top packaging insert B
3. Grip the machine by the handle and bring it into an upright position
4. Remove the machine from the box.
5. Remove the box A



NOTE:

We recommend that you keep all packaging materials because they may be useful in the future to protect the machine and accessories when transporting it to an authorised service centre.

If you do not wish to keep the packaging materials, they should be disposed in accordance with current waste disposal legislation.

3.5 ASSEMBLING THE MACHINE



DANGER!

All the operations described below must be carried out in areas having adequate lighting and only when the battery has been removed from the machine.

After unpacking the machine, it must be assembled as described below (refer to the relevant sections in Chapter 5 for a detailed description of these procedures):

1. Fit the brushes
2. Fit the squeegee and make sure that it is securely fastened and connected to the suction hose.
3. Fill the solution tank.
4. Place the battery into the compartment and connect the connector.

4. TECHNICAL INFORMATION

4.1 GENERAL DESCRIPTION OF COMPONENTS



1. ON/OFF switch
2. Power indicator light
3. Brush / Brush+Water switch
4. Vacuum motor switch
5. Handle
6. Recovery tank fastening clip
7. Suction hose
8. Battery
9. Squeegee
10. Brushes
11. Solution tank
12. Wheels
13. Drain plug
14. Vacuum motor fan
15. Filler plug
16. Handle lock/release lever
17. Recovery tank
18. Vacuum filter
19. Graduated container
20. Battery chargerA

4.2 INSPECTION UPON DELIVERY

To store the machine, lower the handle locking/unlocking lever, make sure that the machine rest on the three wheels (not on the brushes) and that the lever “A” is in a horizontal position as when moving the machine.



CAUTION

Do not store the machine with the brushes resting on the floor, the weight may deform the bristles, reducing their performance.

4.3 BLOCKING / UNLOCKING SQUEEGEE LIFTING

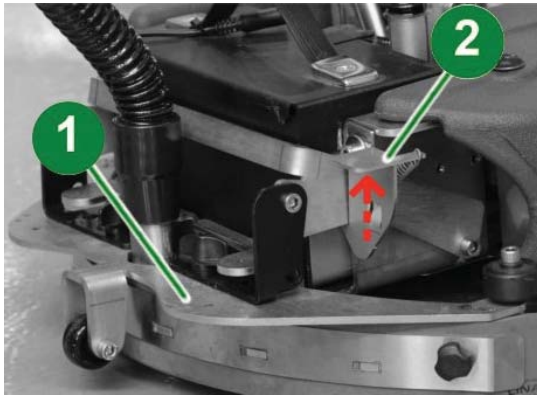

Lifting the squeegee off the floor from plate “1” activate the snap lock “2” which allows the squeegee to remain lifted from the floor.

To bring the squeegee back to the floor, lift the latch “2” releasing it

4.4 CONTROL PANEL

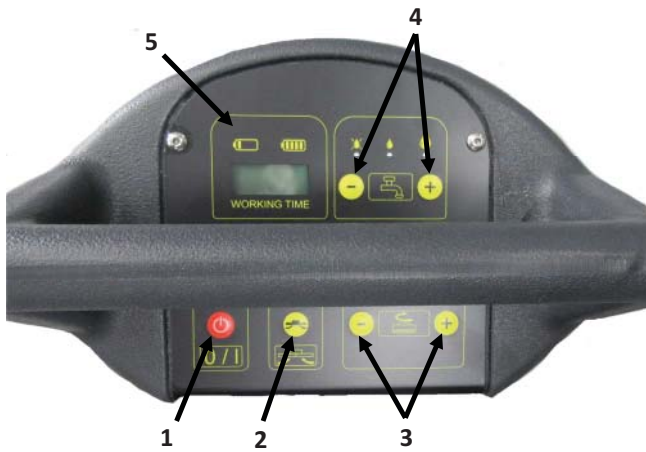

1	Power Button	Turning the machine ON or OFF
2	Suction command button	Activate or deactivate the suction function.
3	Brush speed adjustment buttons	Pressing the + or - buttons increases or decreases the speed of the brushes
4	Water flow adjustment buttons	Pressing the + or - buttons increases or decreases the volume of water solution
5	Battery charge indicator display	The display indicates the battery charge level

4.5 SUCTION POWER ADJUSTMENT CONTROL

Pressing for 5 second simultaneously, buttons 1 and 2, on the display 5, the word Vacuum appears, bellow the sector indicating the battery charge level.

By pressing the button 3 it is possible to increase (pressing +) or decrease (pressing -) the suction power of the machine; this adjustment is signaled on the display 5. To set the selected power level , press the main power button 1 switching OFF the machine. Pressing ON the main power button (button1) the stored setting of suction power level is indicated on the display 5.

There is 8 different setting possibility indicated on the display (1/8, 2/8, 3/8....until 8/8).

4.6 DIMENSION AND TECHNICAL DATA

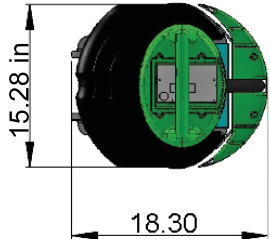
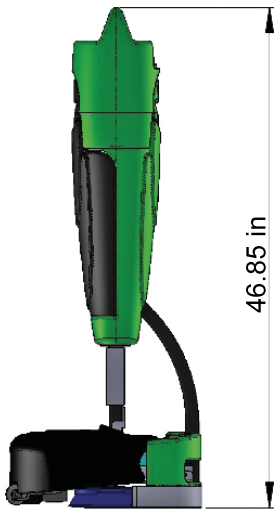

DESCRIPTION	U.M	VALUE
Power Supply	V	36
Performance	m2/h	1200
Cleaning Width	in	157.5
Squeegee blade witch	in	177
Brush diameter	in	2 x 8
Brush speed	RPM	210
Brush presure	lb	49
Brush motor power	W	2 x 36/120
Vacuum motor power	W	36/300
Solution/recovery tank capacity	Gal.	.8 / 1.32
Noise Level	db	66

5. USING THE MACHINE

5.1 PREPARING THE MACHINE

	<p>DANGER! All maintenance work or the replacement of accessories must be carried out in areas with adequate lighting and only after having disconnected the machine from the power supply by unplugging the battery connector.</p>
	<p>CAUTION Before starting, put on non-slip shoes, gloves and any other personal protection equipment indicated by the supplier of the detergent or required by the environment in which the machine is to be used.</p>
	<p>NOTE: Carry out the checks described below before you start to use the machine (refer to the relative sections for a detailed description of these procedures).</p>

1. Fit the brush or pad driver (with abrasive pad) that is suitable for the surface and the work to be performed.
2. Fit the squeegee and make sure that it is securely fastened, connected to the suction hose and that the blades are not excessively worn.
3. Fill the solution tank with a mixture of clean water and a suitable amount of non-foaming detergent (using the graduated container provided).
4. Check the battery charge level and charge if necessary.



NOTE:

To avoid hazards, we recommend that you become familiar with the machine movements by experimenting on a large surface that is free from obstacles.

To obtain the best results in terms of cleanliness and the service life of the appliance, you should follow a few simple, but important procedures:

- Identify the work area and remove all possible obstacles that may get in the way. If the surface is very large, work in contiguous and parallel rectangular areas.
- Choose a straight work trajectory and start working from the area furthest away to avoid going over areas that have already been cleaned.

5.2 RECHARGING THE BATTERY

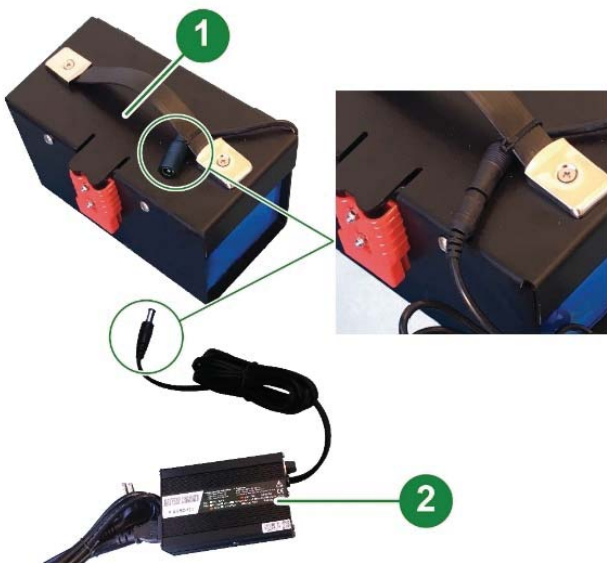

1. Connect the battery extension cable 1 to the plug of the battery charger 2.
2. Plug the battery charger into a mains socket and charge the battery as long as the red LED on the battery charger 2 remains on.
3. When the green LED on the battery charger 2 lights up it means that it is fully charged.
4. Disconnect the plug of the battery charger 2 from the battery extension cable 1.

5.3 FITTING AND REMOVING THE BRUSH



CAUTION

Only use the machine if the brushes or pad drivers, together with abrasive disk, are installed properly..

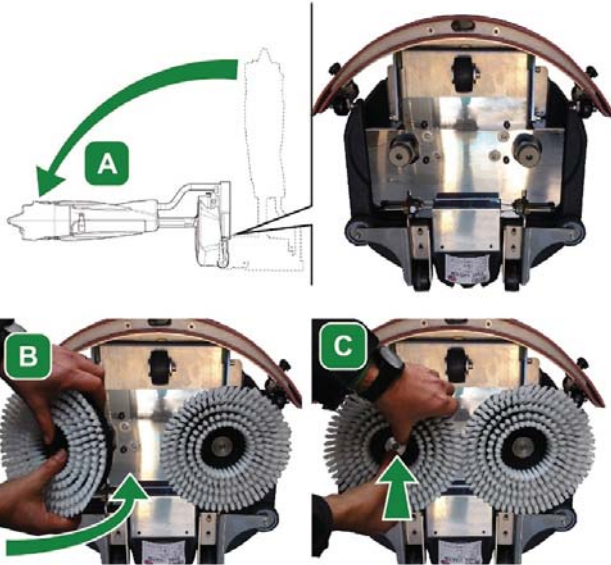

Assembly Procedure:

1. Lock the handle using the locking lever.
2. Grip the handle and, using it as a lever to lift the front of the machine, rotate it (A) backwards.
3. Insert (B) the brushes onto the appropriate pins and press (C) all the way down.

To remove them, follow the procedure indicated in point 3 in reverse.



NOTE:

Follow the same procedure to fit / remove the pad driver.







CAUTION

Replace the brushes / abrasive discs before the length of the bristles or the thickness of the abrasive discs become less than 1 cm. Working with brushes that are excessively worn, or abrasive discs that are excessively thin, may damage the machine and the floor. Regularly check the wear on these parts before starting to use the machine.

5.4 BRUSH TYPES

Four different types of brush are supplied with the machine. Their characteristics differ according to their composition and abrasiveness. Their use depends on the type of floor or the specific application.

ITEM	DESCRIPTION
 <p>PPL O6 BRUSH</p>	Can be used for cleaning hard surfaces such as cement, tiles, clinker, porphyry etc.
 <p>PAD DRIVER</p>	<p>Covered with Velcro and a sponge disc (pad). The abrasiveness of the sponge varies according to its colour: white (soft) to black (very abrasive).</p> <p>Choose the type of sponge according to the type of floor, for example:</p> <ul style="list-style-type: none"> • parquet - white or yellow • PVC - blue or red • wax removal or cement - brown or black.
 <p>P.E.S. BRUSH</p>	Fibre brush with bristles of various diameters (from 0.1 to 0.6 mm). Can also be used without detergent on treated surfaces or wood. Its mixture of bristles means it can also be used just to polish treated floors.
 <p>TYNEX BRUSH</p>	<p>Made of carbon fibre, it can be used only for heavy duty cleaning applications. For example on tiles in industrial kitchens, production departments with machine tools, foundries etc.</p> <p>When used with a suitable detergent, it can be used to remove sludge or dirt consisting of lime deposits or of plant or animal origin (grease).</p> <p>Warning: The Tynex brush MUST NOT be used on delicate flooring materials (such as parquet, marble, PVC etc.).</p>

5.5 MOVING THE MACHINE



To move the machine when not in operation, proceed as follows:

1. Switch the machine off using the main switch on the control panel.
2. Lock the handle using the locking lever.
3. Raise the squeegee using the appropriate lever.
4. Grip the handle and using it as a lever to lift the front of the machine, rotate it (A) backwards until it is resting completely on its wheels.
5. Keeping the machine in this position, push it to where it needs to be used or stored.



CAUTION

Do not use the wheels to support the machine when moving it up or down flights of stairs. It should be lifted (it requires at least 2 people) using the carrying handle..

5.6 FITTING AND REMOVING THE SQUEEGEE

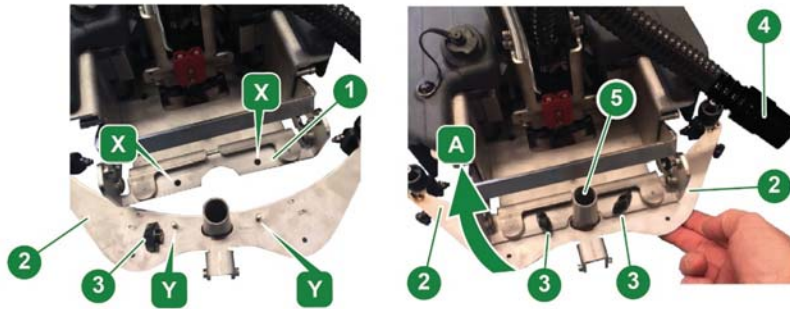

ASSEMBLY PROCEDURE:

1. Position the squeegee support 1 so that it is facing upwards A
2. Insert the squeegee 2 onto the holes X in the support 1.
3. Tighten the knobs 3 securely to fasten the squeegee 2 to the support 1.
4. Insert the suction hose 4 into the sleeve 5.

REMOVAL PROCEDURE:

1. Position the squeegee support 1 so that it is facing upwards A
2. Disconnect the suction hose 4 from the sleeve 5.
3. Loosen the knobs 3 that fasten the squeegee 2 to the support 1.
4. Remove the squeegee 2.

5.7 REPLACING THE SQUEEGEE BLADES

1. Remove the squeegee A from its support (see previous section).
2. Completely unscrew the rear knobs 1 and remove the pins 2.
3. Remove the squeegee blade 4-6 clamping strips 3-7.
4. Remove the rubber blades 4-6 from the body 5 of the squeegee by pulling from one end.
5. To replace the rubber blade, follow the same procedure in reverse starting from the rear blade 6.
6. Fit the rectangular holes on the blades into the seats on the body 5 of the squeegee.
7. Replace the blades 4-6 and the clamping strips 3-7
8. Insert the pins 2 and fasten the whole unit using the knobs 1.

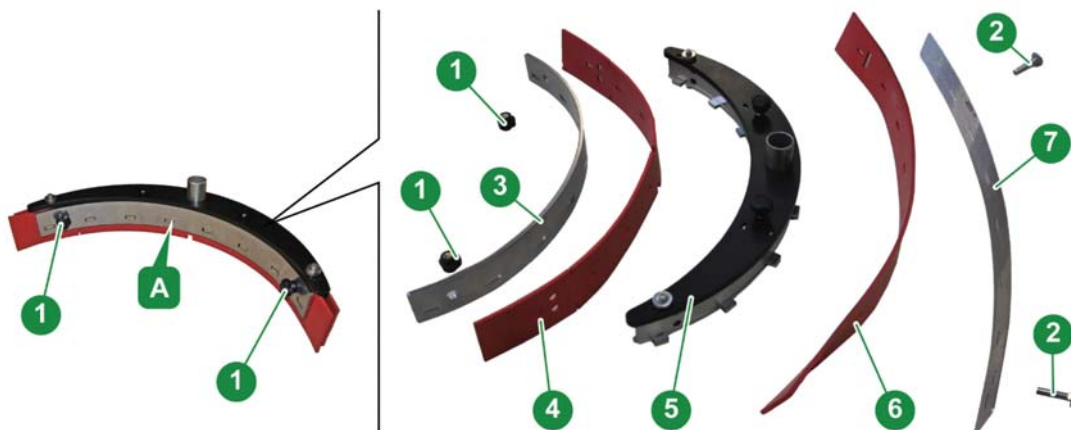

CAUTION

The front rubber blade is different from the rear blade as it has notches through which water can pass.
The clamping strips are identical.

5.8 FILLING AND EMPTYING THE TANK

	<p>NOTE: The temperature of the water or the detergent added should never exceed 50°C. Always empty the recovery tank every time you fill the solution tank..</p>
	<p>CAUTION Use only products suitable for the floor and for the dirt that has to be removed.</p>

FILLING PROCEDURE:

1. Remove the filler plug 1.
2. Pour the required quantity of the chemical product into the tank, considering the percentage (%) indicated by the supplier, according to the full tank capacity indicated on the product sheet.
3. Using the graduated container, pour water into the filling inlet 2.
4. Close the tank with the plug 1.



	<p>CAUTION Always use non-foaming detergents (low foam). The use of other chemical products (such as sodium hypochlorite, oxidisers, solvents or hydrocarbons) may damage or cause irreparable damage to the machine.</p>
--	--

The machine has been designed for use with non-foaming and biodegradable detergents that are specific for scrubber-dryers.

Follow the safety regulations indicated in the relative section and on the detergent container.

Use detergent with a PH value between a minimum of 3 and a maximum of 10.

	<p>NOTE: For a complete list of suitable detergents available, please contact the machine manufacturer.</p>
--	--

EMPTYING PROCEDURE:



1. Unscrew the drain plug 3, together with the filter 4, located in the lower part of the tank.
2. Wait for the tank to empty completely.
3. Screw the drain plug back on tightly 3.

5.9 DRAINING THE RECOVERY TANK

1. Move the machine to a suitable place in which to empty the dirty water, preferably close to a drain (comply with national regulations regarding the disposal of waste water).
2. Release the fastening clips 1
3. Remove the tank 2
4. Disconnect the hose 3 from its seat.
5. Unscrew the lower plug 4
6. Pour the recovered water into the drain until the tank is completely empty 2.
7. Screw the lower plug back on 4
8. Insert the hose 3 into its seat, taking care to position it properly as shown in the picture.
9. Place the tank 2 back onto the handle 5.
10. Secure it with the fastening clips 1



5.10 OPERATING THE MACHINE

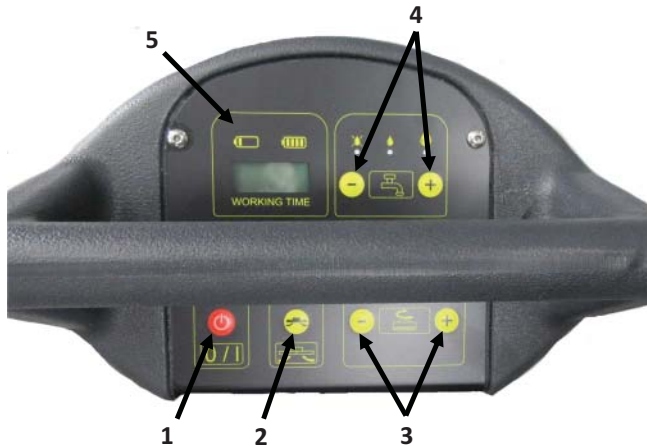

1. Switch on the machine pressing powerbotton 1.
2. Lower the squeegee.
3. Lift the lever 6 to release the handle 7.
4. Start the brushes and the dispensing of the solution (water + detergent) using switch 3 and 4
5. Turn on the vacuum using the switch 2.
6. Wash the floor by moving slowly forwards and follow the machine as it progresses due to the movement of the brushes.

	<p>CAUTION Remember to raise the squeegee before reversing in order to avoid damaging it.</p>
	<p>NOTE: <i>The machine is fitted with a motor overload protection system that stops the motor in the event that the ON/OFF switch is pressed repeatedly at short intervals. The machine must be restarted in order to resume normal operation.</i></p>

5.11 FLOOR CLEANING INSTRUCTIONS

PREPARATION AND WARNINGS

Remove any loose solid residues from the surface to be treated (using suitable equipment such as vacuum cleaners, sweepers, etc.) If this is not done, the solid dirt could prevent the squeegee from working properly and prevent the floor from being dried correctly.

This machine must only be used by trained personnel.

	<p>CAUTION Do not obstruct the motor cooling fan grille.</p>
--	---

DIRECT WASHING OR FOR SLIGHTLY DIRTY SURFACES

Scrubbing and drying in a single pass.

Prepare the machine and use it as described in section OPERATING THE MACHINE.



NOTE:

Never use the machine without a detergent solution as it may damage the floor.

INDIRECT WASHING OR FOR VERY DIRTY SURFACES

Scrubbing and drying in multiple passes.

Prepare the machine and use it as described in section OPERATING THE MACHINE.

First step:

Wash the floor as described in section OPERATING THE MACHINE.

without drying it.

Give the detergent solution time to act on the dirt, as indicated in the instructions of the detergent used.

Second step:

Proceed as explained in the previous section and also dry the floor.





NOTE:

Never use the machine without a detergent solution as it may damage the floor.

POST-CLEANING OPERATIONS

1. Turn off the detergent dispensing function.
2. After having completely dried the surface of any traces of water, wait a few seconds, then raise the squeegee and turn off the vacuum motor.
3. Go to a suitable place where to drain the tanks.
4. Empty and clean the tanks (see sections FILLING AND EMPTING THE SOLUTION TANK and DRAINING THE RECOVERY TANK).
5. Turn off the machine using the ON / OFF switch
6. Lock the handle using the locking lever.
7. Charge the battery, if necessary.

6. MAINTENANCE

	<p>DANGER!</p> <p>All maintenance work or the replacement of accessories must be carried out in areas with adequate lighting and only after having disconnected the machine from the power supply by unplugging the battery connector.</p>
	<p>NOTE:</p> <p>All work on the electrical system and all maintenance and repair work (especially work not specifically described in this manual) should only be carried out at authorised service centres or by skilled personnel with experience in the field and knowledge of the relevant safety regulations. Carrying out regular maintenance on the machine, carefully following the manufacturer's instructions ensures better performance and a longer machine service life.</p>

6.1 TANKS

Drain the two tanks as described in the relative sections FILLING AND EMPTING THE SOLUTION TANK and DRAINING THE RECOVERY TANK.

Remove any solid dirt by filling and draining the tanks until all dirt has been eliminated. Do this using a hose or similar item and only wash the inside of the tank.

	<p>CAUTION</p> <p>Water temperatures in excess of 50°, high-pressure washers or excessively powerful sprays can damage the tanks and the machine. Leave the plugs of the tanks open (only while the machine is not being used) so that the tanks can dry and prevent the formation of unpleasant odors.</p>
---	--

6.2 DETERGENT SOLUTION TANK FILTER



1. To clean the detergent solution filter, remove the plug 1 and the filter element 2.
2. After cleaning, place the filter element 2 back into its seat and screw the plug back on 1.

6.3 SUCTION HOSE

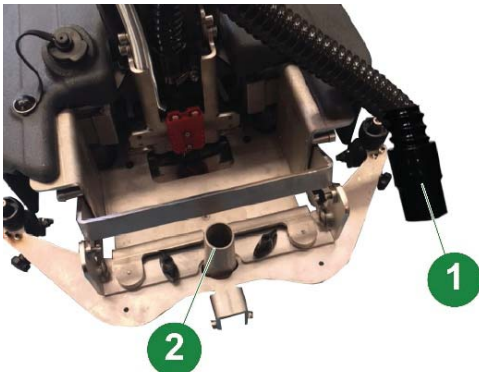

1. Disconnect the suction hose 1 from the squeegee 2.
2. The hose 1 can now be cleaned and any obstructions removed.
3. After cleaning, insert the hose 1 firmly onto the squeegee body 2.

6.4 SQUEEGEE



CAUTION

Do not handle the squeegee with bare hands: wear gloves and any other protective clothing that may be necessary.

Remove the squeegee from the machine and clean it under running water using a sponge or brush. Check the effectiveness and the wear of the rubber blades that are in contact with the floor. They are designed to scrape the detergent-water film on the floor and to isolate that area of the surface to help the vacuum motor reach the maximum vacuum pressure: this ensures that the machine will dry the floor completely.

Working like this continuously causes the sharp edge of the blade to become round or to wear, thereby reducing its drying efficiency. The squeegee blades must therefore be replaced fairly often.

If necessary, turn the blades in order to use the other sharp edges or to install new ones (see section **REPLACING THE SQUEEGEE BLADES**).



6.5 VACUUM FILTER

1. Release the fastening clips 1
2. Remove the tank 2
3. Remove the filter 3 from its seat and clean it under running water.
4. After cleaning, replace the filter 3 in its seat
5. Put the tank 2 back into the handle.



6.6 ACCESSORIES

Remove and clean the brush or pad driver (see section FITTING AND REMOVING THE BRUSH). Check that the brushes work evenly on the surface (check for any irregular wear on the brushes or abrasive disks).

	<p>CAUTION To avoid damaging the floor and the machine, make sure that no foreign objects, such as metallic parts, screws, chippings, string or similar items, have become caught in the brushes.</p>
	<p>NOTE: <i>Only use accessories recommended by the manufacturer: Using products that are non-compliant may affect safety and damage the machine.</i></p>

6.7 MACHINE BODY

Use a sponge or a damp cloth to clean the outside of the machine and if necessary, use soft brush to eliminate stubborn dirt.
The machine's impact resistant surface is rough to make it harder to see scratches produced during use. However, this does not make it easy to remove stubborn stains from its surface.

	<p>CAUTION Never use steam cleaners, hoses with running water or high-pressure washers.</p>
---	--

6.8 MAINTENANCE SCHEDULE

	<p>NOTE: <i>For all the operations described here, refer to the detailed instructions and warnings given in the relative sections.</i></p>
--	---

The frequency with which the routine maintenance is carried out is determined by the number of complete machine discharge cycles.

The machine has an autonomy of approximately 1 hour. Each cycle is considered to be 1 working hour.

CYCLES	DESCRIPTION
1	Clean the squeegee (see section SQUEEGEE) Clean the solenoid valve filter (see section CLEAR WATER TANK FILTER).
5	Clean the vacuum filter (see section VACUUM FILTER). Clean the recovery tank seals 1 and 2 using a damp cloth.
10	Clean the bottom plate 3 and particularly the clean water nozzles 4 using a damp cloth or abrasive sponge

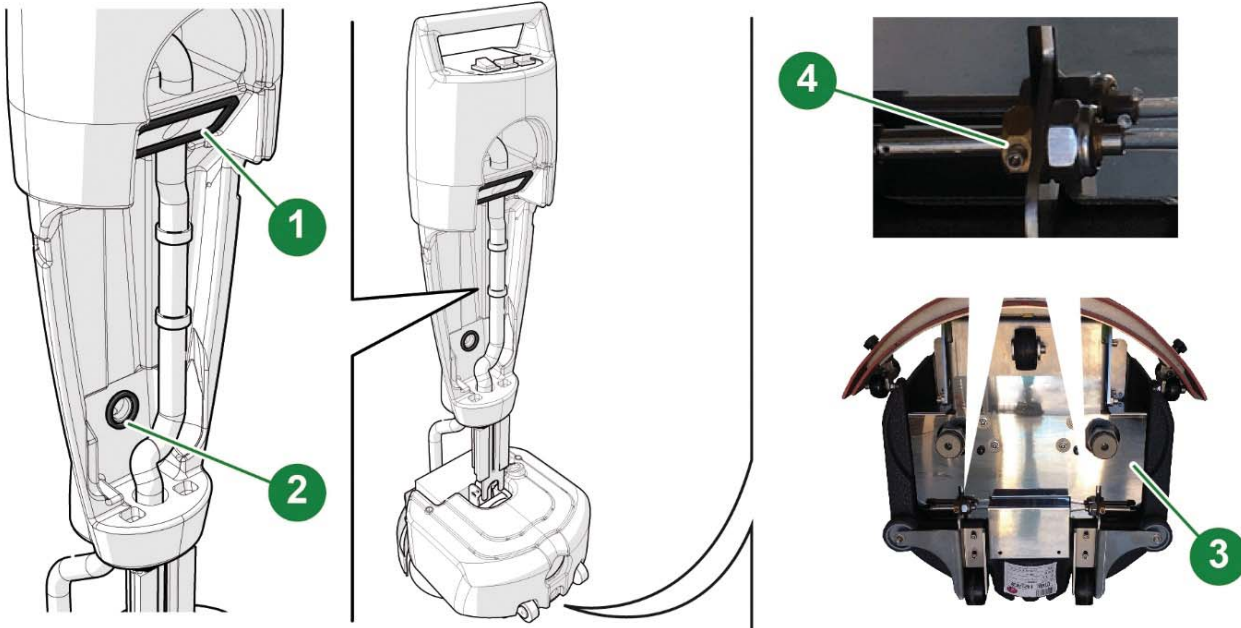

6.9 EXTRAORDINARY MAINTENANCE

Even though the machine has been carefully built and conforms with the most stringent quality tests, the electrical and mechanical components are inevitably subject to wear and ageing after long periods of use. In order for the machine to provide safe and trouble-free service, it is recommended that your machine be thoroughly inspected every year at a service centre authorised by the manufacturer (or by someone specialised in the field who has the proper skills and who is familiar with all the relevant safety regulations contained in this manual).

This may need to be done more frequently if the machine is used in particularly harsh conditions and / or if it has not been properly maintained.

6.10 RECOMMENDED SPARE PARTS

To get the most out of your machine, it is recommended that you always keep a stock of the common consumables and to schedule routine and extraordinary maintenance. Contact your dealer for a list of these spare parts.

7. TROUBLESHOOTING



CAUTION

The content of this chapter is not exhaustive but it aims to provide information regarding the most common problems in order to help the user to troubleshoot faults.

The instructions under the heading “SOLUTION” in the table below DO NOT AUTHORISE work to be carried out that can affect safety.

Please refer to the corresponding section in this manual for details of the type of action to take.

PROBLEM	CAUSE	SOLUTION
THE MACHINE DOES NOT SWITCH ON	Low battery	Check the battery connection. Check the battery charge level. Replace the battery.
THE BRUSH DOESN'T ROTATE	Low battery	Check the battery connection. Check the battery charge level. Replace the battery.
THE VACUUM MOTOR DOESN'T START	Electronic cards are in standby	Turn the machine off, and then on again.
THE VACUUM MOTOR DOES NOT REMOVE THE WATER	Low battery	Check the battery connection. Check the battery charge level. Replace the battery.
THE WATER DOES NOT REACH THE BRUSH	Electronic cards are in standby	Turn the machine off, and then on again
	Suction hose and / or filter clogged	Clean the suction hose and / or filter
	The water tank is empty or the internal filter is clogged	Remove the tank drain plug and clean the filter.

Minuteman International Made Simple Commercial Limited Warranty REVISION P EFFECTIVE 5/1/2017

Minuteman International, Inc. warrants to the original purchaser/user that the product is free from defects in workmanship and materials under normal use. Minuteman will, at its option, repair or replace without charge, parts that fail under normal use and service when operated and maintained in accordance with the applicable operation and instruction manuals. All warranty claims must be submitted through and approved by factory authorized repair stations.

This warranty does not apply to normal wear, or to items whose life is dependent on their use and care, such as belts, cords, switches, hoses, rubber parts, brushes, electrical motor components or adjustments. Parts manufactured by Minuteman are covered by and subject to the warranties and/or guarantees of their manufacturers. Please contact Minuteman for procedures in warranty claims against these manufacturers.

Special warning to purchaser -- Use of replacement filters and/or pre-filters not manufactured by Minuteman or its designated licensees, will void all warranties expressed or implied. A potential health hazard exists without original equipment replacement.

All warranted items become the sole property of Minuteman or its original manufacturer, whichever the case may be.

Minuteman disclaims any implied warranty, including the warranty of merchantability and the warranty of fitness for a particular purpose. Minuteman assumes no responsibility for any special, incidental or consequential damages.

This limited warranty is applicable only in the U.S.A. and Canada, and is extended only to the original user/purchaser of this product. Customers outside the U.S.A. and Canada should contact their local distributor for export warranty policies. Minuteman is not responsible for costs or repairs performed by persons other than those specifically authorized by Minuteman. This warranty does not apply to damage from transportation, alterations by unauthorized persons, misuse or abuse of the equipment, use of non-compatible chemicals, or damage to property, or loss of income due to malfunctions of the product.

If a difficulty develops with this machine, you should contact the dealer from whom it was purchased.

This warranty gives you specific legal rights, and you may have other rights which vary from state to state. Some states do not allow the exclusion or limitation of special, incidental or consequential damages, or limitations on how long an implied warranty lasts, so the above exclusions and limitations may not apply to you.

Model	Parts	Labor	Poly	Travel**
Cord Electric Group	5yrs	3yrs	12yrs	90 days
Battery Auto Scrubbers (incl. on board charger)	5yrs	3yrs	12yrs	90 days
Battery and Manual Sweepers	3yrs	3yrs	12yrs	90 days

Exceptions.....

Model	Parts	Labor	Poly	Travel**
Port A Scrub, all models (incl. on board charger)	1yr	6months	12yrs	90 days
A3S Blower	1yr	1yr	0	0
Phenom Dual Motor Upright Vacuums	2yrs	2yrs	0	0
Explosion Proof Vacuum	1yr	1yr	0	0
Propane Burnisher	1yr	1yr	0	90 days
E14BQP and E14115 scrubber	1yr	1yr	12yrs	90 days
EZ MOP 360	1yr	1yr	0	90 days
**Travel, 2 hours max				

<i>Stand-alone Battery Chargers:</i>	One year
<i>Replacement Parts:</i>	Ninety days
<i>Batteries:</i>	0-3 months full replacement, 4-12 months pro-rate
<i>Polypropylene Plastic Tanks:</i>	12yr warranty, no additional labor

“Excellence Meets Clean”

**Minuteman is a Full Line Manufacturer of Sweepers and Scrubbers,
for Industrial Facilities.**

14N845 U.S. Route 20, Pingree Grove, IL 60140 USA
Phone (800) 323-9420 - www.minutemanintl.com
A Member of the Hako Group

988765UM
Rev A 03/18